



## General Use Plastic and Glass ORP Electrodes



---

Choice of Extended Rod or Band-Type Platinum

---

Silver or Gold Versions Available

---

Combination or Half Cell Designs

---

Single or Double Reference Junction

---

Sealed or Refillable Junctions

---

Glass or Plastic Bodies

---

### **Which material and configuration should I choose?**

Sensorex makes both types--- separate ORP half cells and combination ORP electrodes. The convenience of handling one combination electrode as compared to using separate ORP and reference electrodes has been well established in laboratory and portable ORP measurements. And since the price of Sensorex combination electrodes is much less than the total price of the separate electrodes, separate electrodes are used only for special purposes.

Sensorex utilizes 99.993% pure platinum rod to ensure there are no impurities in the platinum that could cause adverse reactions or interferences in ORP measurements

### **Glass or Plastic Body Electrodes?**

Sensorex makes both body types and they provide the identical excellent ORP measurements. Today's plastics allow ORP electrodes to be constructed with sturdy and chemically resistant epoxy or premium ULTEM bodies. A recessed protected design of the Sensorex plastic body electrodes extends over the extended tip or band measuring surface so that the surface cannot be damaged.

### **Single or Double Junction Reference?**

Most ORP measurements can be made with single junction reference electrodes. However, materials such as heavy metals, proteins and sulfides can precipitate at the junction. Double junction designs use a buffering salt such as KNO<sub>3</sub> in the lower chamber contacting the sample, and prevent these reactions. For separate reference half cells, see LabSpecs.

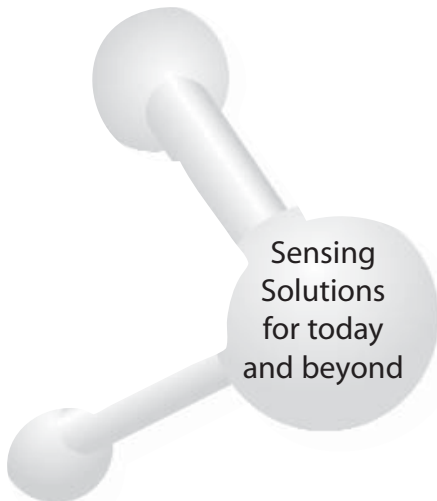

### GLASS BODY COMBINATION ORP ELECTRODES

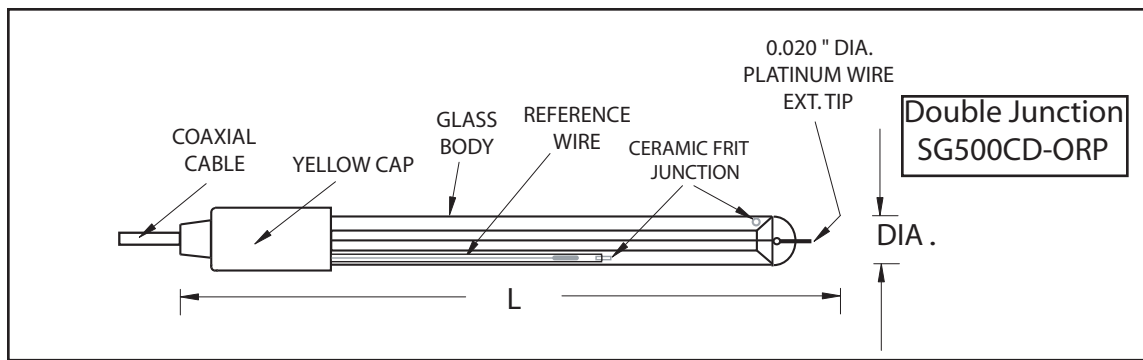
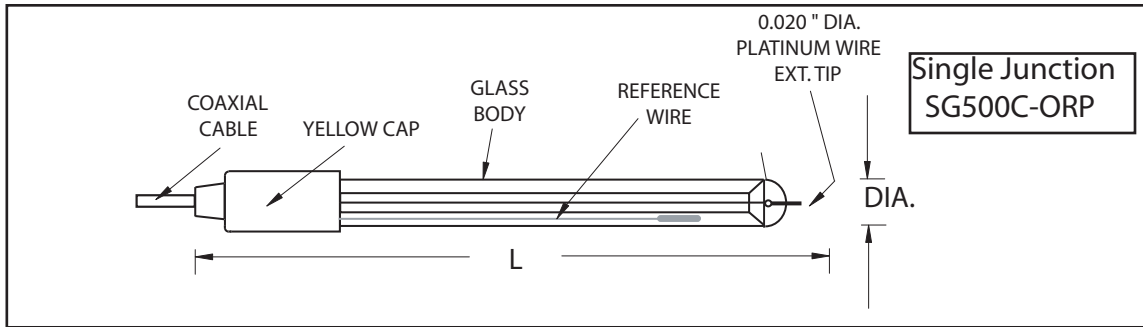

### EPOXY BODY COMBINATION ORP ELECTRODES

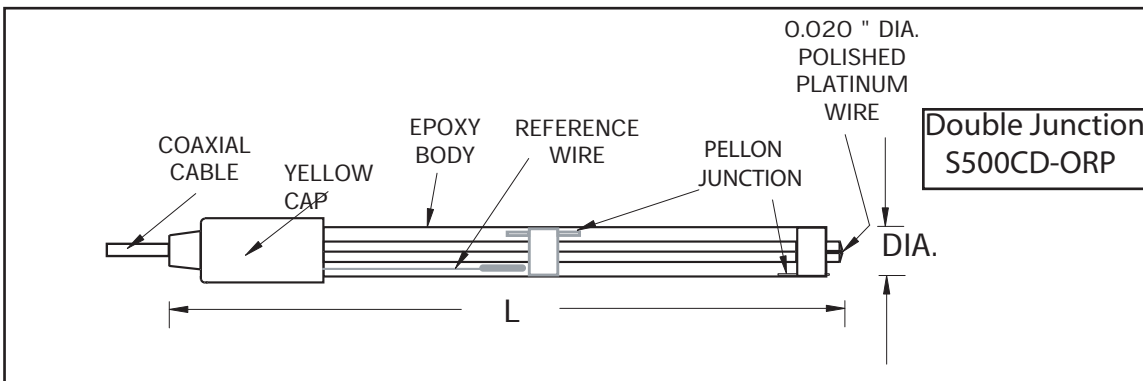
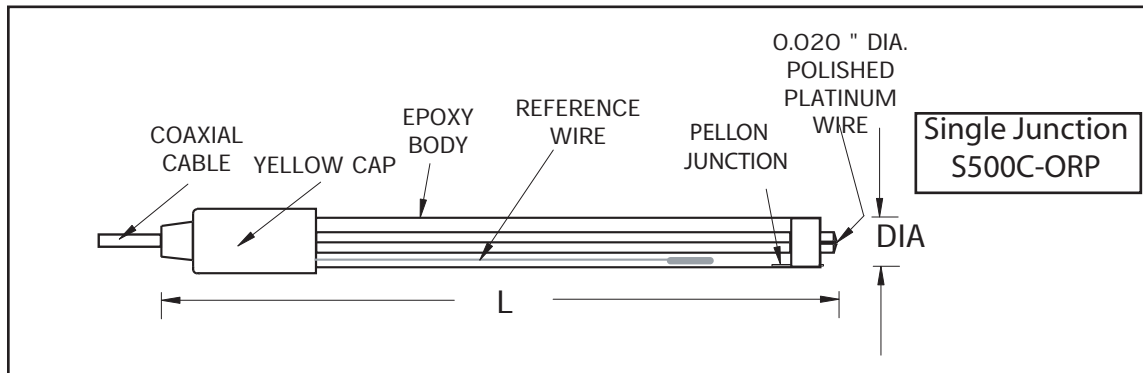

# EPOXY BODY COMBINATION ORP ELECTRODES(cont)

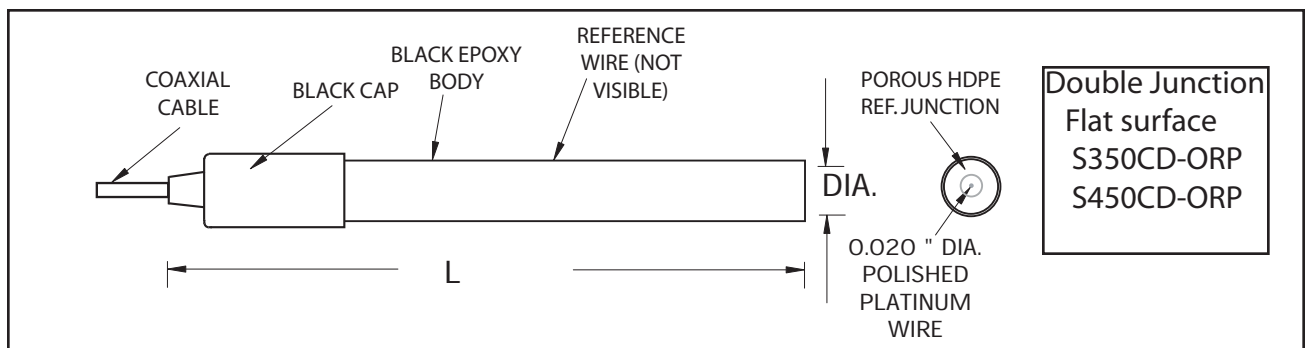
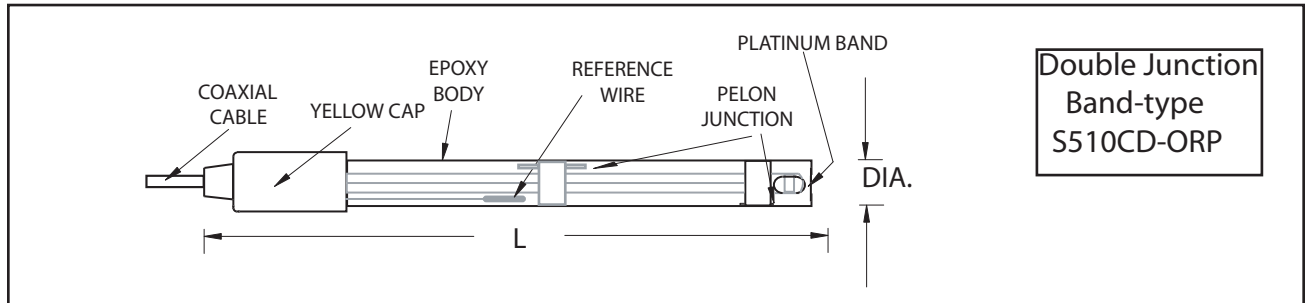
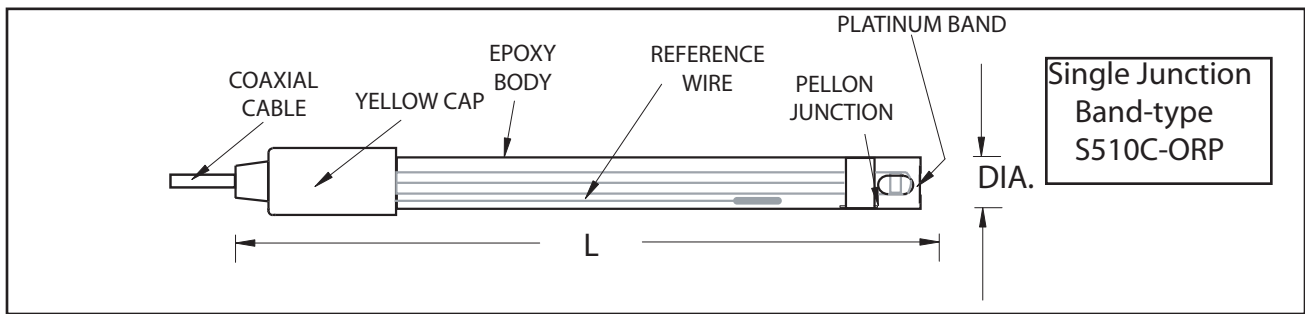
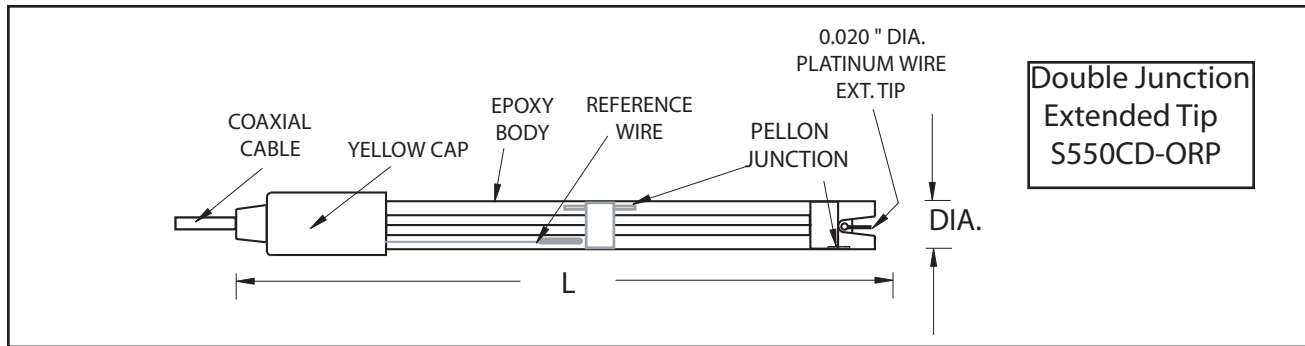
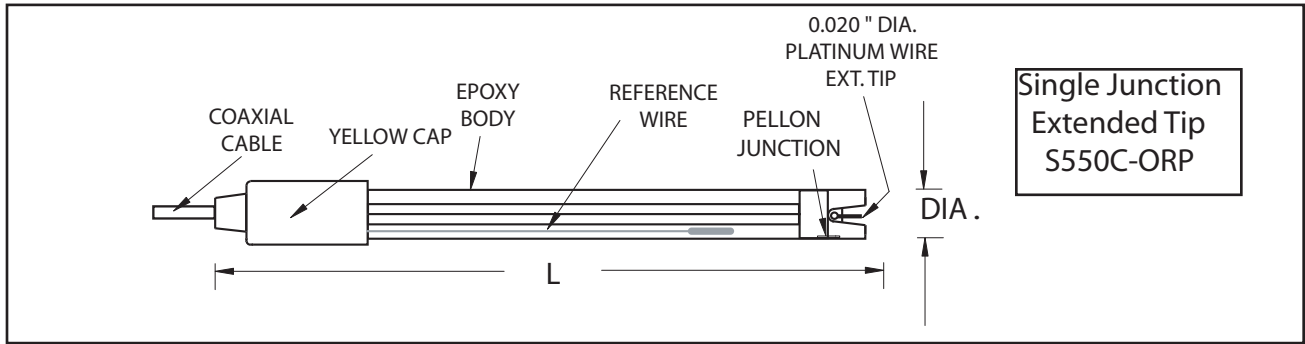



How do I choose the appropriate ORP laboratory/portable electrode for my use?

OR: Select by electrode type you currently use:

- a) Platinum, silver or gold
- b) Polished tip, exposed rod or band
- c) Sealed or re-fillable reference
- d) Epoxy or glass body
- e) Dimension required Length and diameter
- f) Separate ORP half-cell/separate reference half-cell(see LabSpecs for reference half-cells)

## Product Guide Lab ORP (Redox)

### Application

### Sensorex Part Number

	Glass Body-	Epoxy Body-polished tip	Epoxy body - Extended tip	Epoxy Body-Band tip
Standard Laboratory	SG500C-ORP	S500C-ORP	S550C-ORP	S510C-ORP
Field Use	-----	S500CD-ORP	S550CD-ORP	S510CD-ORP
Low Ionic conditions	Inquire	S500CD-ORP-LC	Not available	Not available
Test tubes	Inquire	S900C-ORP	Not available	Not available
Tall flasks/ reactors	Inquire	S300C-ORP	Not available	Not available
Mixed aqueous/organic	Inquire	-----	Not suggested	Not suggested
Contain Heavy metals	SG500CD-ORP	S500CD-ORP	970884D	S510CD-ORP
Soil Samples	Not suggested	S500CD-ORP	970884D	S510CD-ORP
Strong reducing agents (cyanide,...)	Inquire	S550C-ORP-Au (gold)	Not available	Not suggested

### Ordering Information

Model Number	Dimensions (L x dia.)	Measuring Surface	Junction Type
S500C-ORP	6" (150mm) x 1/2" (12mm)	Platinum Polished Rod	Single Junction
S500CD-ORP	6" (150mm) x 1/2" (12mm)	Platinum Polished Rod	Double Junction
S550C-ORP	6" (150mm) x 1/2" (12mm)	Platinum Extended Tip	Single Junction
S550CD-ORP	6" (150mm) x 1/2" (12mm)	Platinum Extended Tip	Double Junction
S510C	6" (150mm) x 1/2" (12mm)	Platinum Band	Single Junction
S510CD	6" (150mm) x 1/2" (12mm)	Platinum Band	Double Junction
S550C-ORP-Au	6" (150mm) x 1/2" (12mm)	Gold Polished Rod	Double Junction
S350CD-ORP	6" (150mm) x 1/2" (12mm)	Platinum flat	Double Junction - HDPE
S450CD-ORP	4.5" (115mm) x 5/8" (15mm)	Platinum flat	Double Junction - HDPE

**Note: All electrodes are supplied with 30" cable standard. Please specify connector type when ordering.**

Sensorex ORP calibration kit (B125) as well as Zobel Solution +225mV (B225) buffers are available in pints and quarts.